



**8" (200 mm)**  
Submersible Pumps  
50 Hz.

---

# Product Data

## Materials: 8" submersible pump

Pos.*	Component	8" pump
1	Bowl / Diffuser	Grey iron 200 ISO 185
2	Impeller	Bronze**
3	Neck ring	Nitrile rubber
4	Shaft	S.SI AISI 410
5	Shaft sleeve	S.SI AISI 410
6	Couple	S.SI AISI 410
7	Delivery casing	Grey iron 200 ISO 185
8	Suction case	Grey iron 200 ISO 185
9	Bearing bush	Nitrile rubber
10	Strainer	S.S AISI 202

**Note:** \* For parts position see sectional drawing in adjoining page.

\*\* S.S AISI 410 available on request.



# Product Data

## Sectional drawing: 8" submersible pump

8"

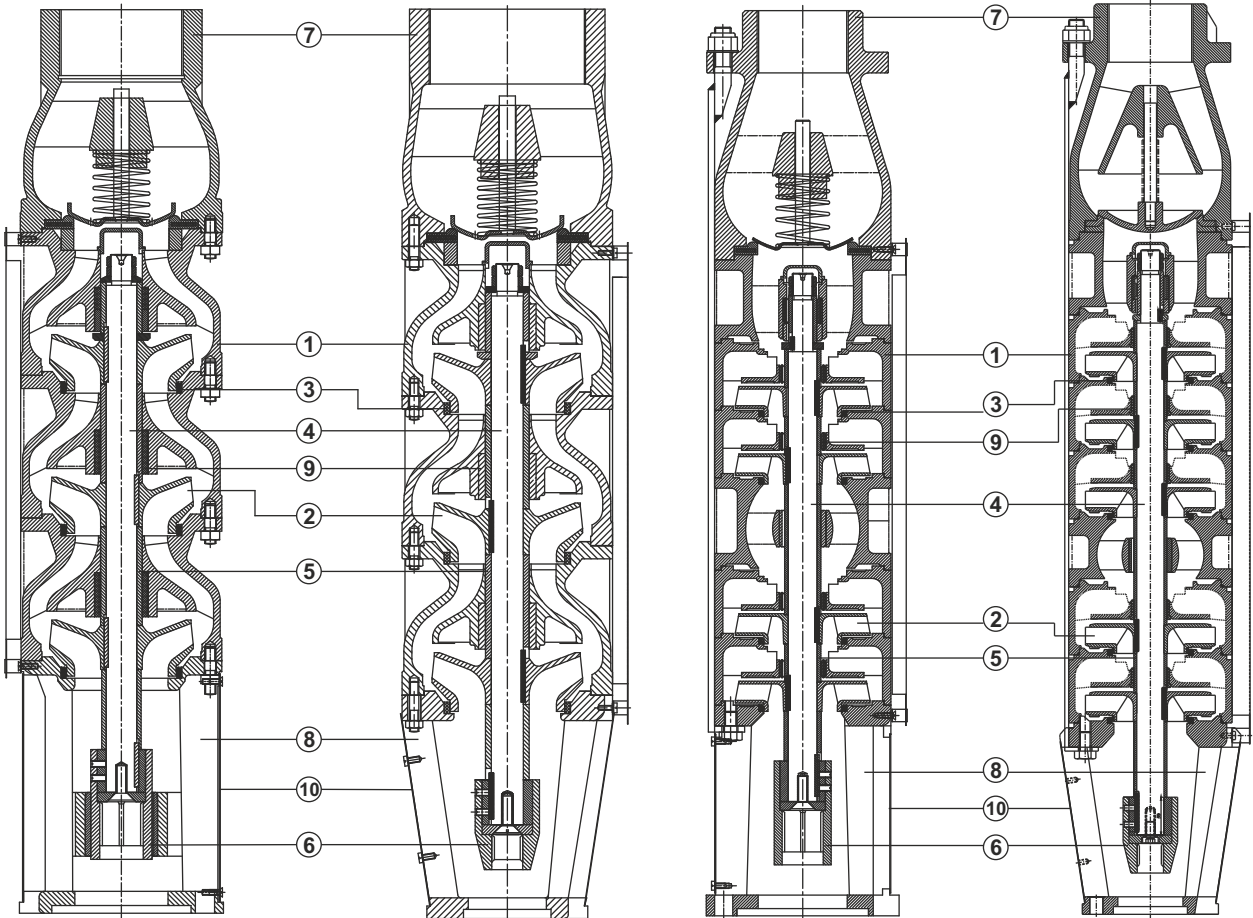

**VM8040, VM8050  
VM8060, VM8070  
VM8080, VM8100**

*With 8" Motor joining*

**VM8040, VM8050  
VM8060, VM8070  
VM8080, VM8100**

*With 6" Motor joining*

**VR8150, VR8250,  
VR8300, VR8400,  
VR8500**

*With 8" Motor joining*

**VR8150, VR8250,  
VR8300, VR8400,  
VR8500**

*With 6" Motor joining*



# VR8150

## Radial Flow Pump Characteristic Curves & Technical Data

# 8"

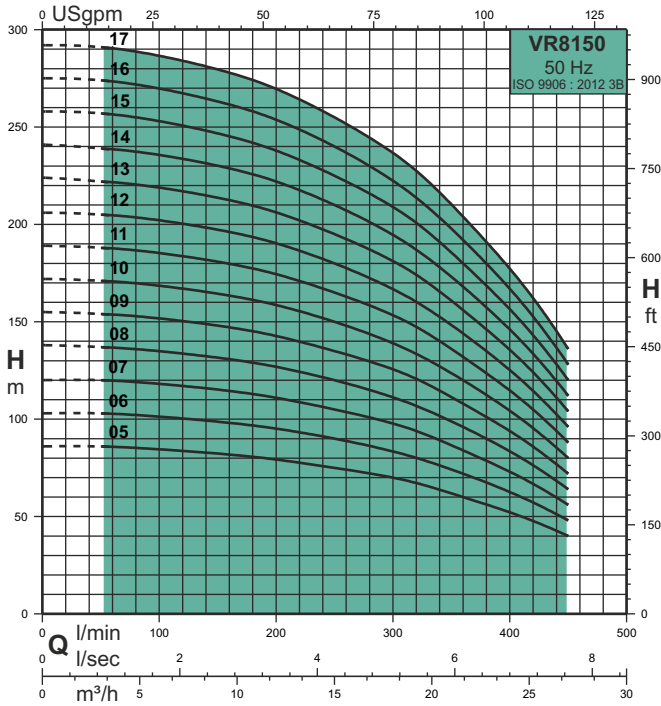

Pump type	P <sub>2</sub>		Q							
	kW	HP	m <sup>3</sup> /h	0	11,4	15,0	18,9	21,3	24,6	27,0
VR8150-05	5,5	7,5	Q l/min	0	190	250	315	360	410	450
VR8150-06	7,5	10	H m	86	80	75	68	60	50	40
VR8150-07	7,5	10		103	96	90	81	72	60	48
VR8150-08	9,3	12,5		120	112	105	95	84	70	56
VR8150-09	11	15		138	128	120	108	96	80	64
VR8150-10	11	15		155	144	135	122	108	90	72
VR8150-11	13	17,5		172	160	150	135	120	100	80
VR8150-12	13	17,5		189	176	165	149	132	110	88
VR8150-13	15	20		206	192	180	162	144	120	96
VR8150-14	18,5	25		224	208	195	176	156	130	104
VR8150-15	18,5	25		241	224	210	189	168	140	112
VR8150-16	18,5	25		258	240	225	203	180	150	120
VR8150-17	18,5	25		275	256	240	216	192	160	128
				292	272	255	230	204	170	136

Nominal flow rate	250 l/min
Flow range	50 - 450 l/min
Head range	Up to 516 metres
Max. pump efficiency (η)	63%
Motor power	5,5 - 37 kW
Rated speed	2900 rpm
Pipe connection	G 3

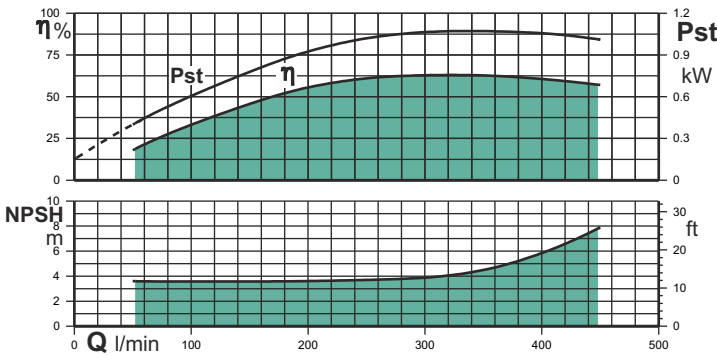
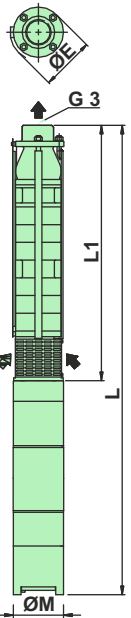

Pump type	P <sub>2</sub>		Dimensions						Gross weight [kg]			Gross volume [m <sup>3</sup> ]		
			L1 [mm]	ØE [mm]	WF motor				Pump	Pump + WFM		Pump	Pump + WFM	
					Size	ØM [mm]	L [mm]			1 ~	3 ~		1 ~	3 ~
							1 ~	3 ~						
VR8150-05	5,5	7,5	678	198	6"	142	-	1386	70,0	-	130,2	0,0880	-	0,1440
VR8150-06	7,5	10	723	198	6"	142	-	1481	74,0	-	139,5	0,0880	-	0,1440
VR8150-07	7,5	10	767	198	6"	142	-	1525	80,0	-	145,5	0,0960	-	0,1520
VR8150-08	9,3	12,5	812	198	6"	142	-	1610	85,0	-	154,4	0,0960	-	0,1520
VR8150-09	11	15	856	198	6"	142	-	1689	90,0	-	163,6	0,0960	-	0,1520
VR8150-10	11	15	989	198	6"	142	-	1822	104,0	-	177,6	0,1260	-	0,1820
VR8150-11	13	17,5	1034	198	6"	142	-	1897	108,0	-	184,0	0,1260	-	0,1820
VR8150-12	13	17,5	1078	198	6"	142	-	1941	113,0	-	189,0	0,1260	-	0,1820
VR8150-13	15	20	1123	198	6"	142	-	2056	118,0	-	202,4	0,1320	-	0,1980
VR8150-14	18,5	25	1167	198	6"	142	-	2160	124,0	-	214,5	0,1350	-	0,2010
VR8150-15	18,5	25	1212	198	6"	142	-	2205	130,0	-	220,5	0,1380	-	0,2040
VR8150-16	18,5	25	1256	198	6"	142	-	2249	136,0	-	226,5	0,1510	-	0,2170
VR8150-17	18,5	25	1390	198	6"	142	-	2383	141,0	-	231,5	0,1570	-	0,2230

**Note:** ØE = For single cable motor maximum diameter of pump inclusive of cable guard. For two cable motor maximum diameter of pump inclusive of cable guard will increase by 4 mm.

All dimensions in mm unless otherwise noted.



# VR8150

## Radial Flow Pump Characteristic Curves & Technical Data

# 8"

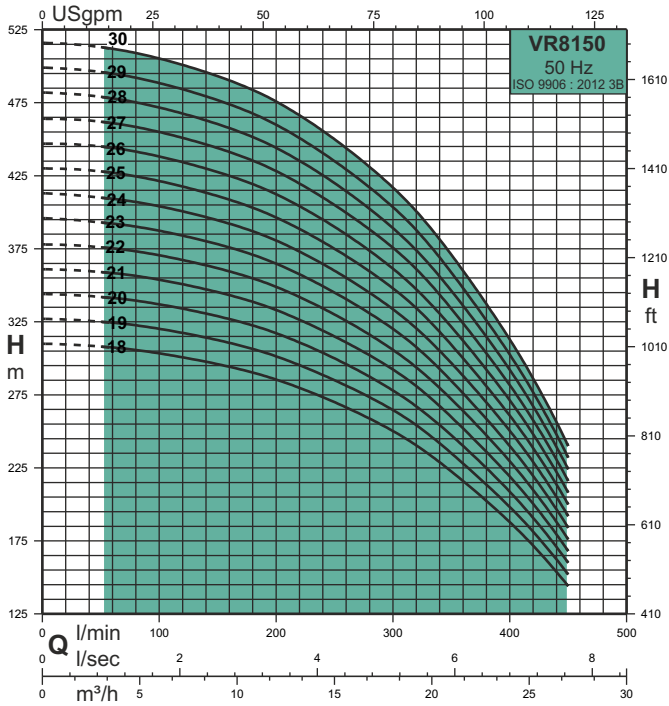

Pump type	P <sub>2</sub>		Q m <sup>3</sup> /h	Q l/min									
	kW	HP		0	11,4	15,0	18,9	21,3	24,6	27,0			
VR8150-18	22	30	H m	310	288	270	243	216	180	144			
VR8150-19	22	30		327	304	285	257	228	190	152			
VR8150-20	22	30		344	320	300	270	240	200	160			
VR8150-21	26	35		361	336	315	284	252	210	168			
VR8150-22	26	35		378	352	330	297	264	220	176			
VR8150-23	26	35		396	368	345	311	276	230	184			
VR8150-24	30	40		413	384	360	324	288	240	192			
VR8150-25	30	40		430	400	375	338	300	250	200			
VR8150-26	30	40		447	416	390	351	312	260	208			
VR8150-27	30	40		464	432	405	365	324	270	216			
VR8150-28	37	50		482	448	420	378	336	280	224			
VR8150-29	37	50		499	464	435	392	348	290	232			
VR8150-30	37	50		516	480	450	405	360	300	240			

Nominal flow rate	250 l/min
Flow range	50 - 450 l/min
Head range	Up to 516 metres
Max. pump efficiency (η)	63%
Motor power	5,5 - 37 kW
Rated speed	2900 rpm
Pipe connection	G 3

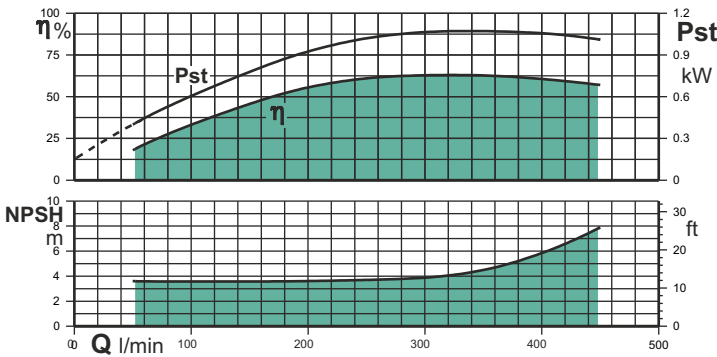
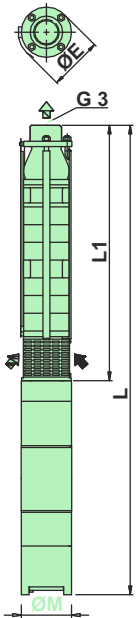

Pump type	P <sub>2</sub>		Dimensions						Gross weight [kg]			Gross volume [m <sup>3</sup> ]		
			L1 [mm]	ØE [mm]	WF motor				Pump	Pump + WFM		Pump	Pump + WFM	
					Size	ØM [mm]	L [mm]			1 ~	3 ~		1 ~	3 ~
			1 ~	3 ~										
VR8150-18	22	30	1435	198	6"	142	-	2488	147,0	-	246,0	0,1640	-	0,2300
VR8150-19	22	30	1479	198	6"	142	-	2532	153,0	-	252,0	0,1700	-	0,2360
VR8150-20	22	30	1524	198	6"	142	-	2577	159,0	-	258,0	0,1760	-	0,2420
VR8150-21	26	35	1568	198	6"	142	-	2701	163,0	-	276,5	0,1760	-	0,3090
VR8150-22	26	35	1613	198	6"	142	-	2746	167,0	-	280,5	0,1760	-	0,3090
VR8150-23	26	35	1657	198	6"	142	-	2790	172,0	-	285,5	0,1830	-	0,3160
VR8150-24	30	40	1702	198	6"	142	-	2885	178,0	-	303,0	0,1900	-	0,3230
VR8150-25	30	40	1746	198	6"	142	-	2929	184,0	-	309,0	0,1960	-	0,3290
VR8150-26	30	40	1791	198	6"	142	-	2974	190,0	-	315,0	0,2030	-	0,3360
VR8150-27	30	40	1835	198	6"	142	-	3018	195,0	-	320,0	0,2090	-	0,3420
VR8150-28	37	50	1880	198	6"	142	-	3193	201,0	-	336,0	0,2160	-	0,3560
VR8150-29	37	50	1924	198	6"	142	-	3237	205,0	-	340,0	0,2160	-	0,3560
VR8150-30	37	50	1969	198	6"	142	-	3282	209,0	-	344,0	0,2160	-	0,3560

**Note:** ØE = For single cable motor maximum diameter of pump inclusive of cable guard.  
For two cable motor maximum diameter of pump inclusive of cable guard will increase by 4 mm.  
All dimensions in mm unless otherwise noted.





# VR8250

## Radial Flow Pump Characteristic Curves & Technical Data

# 8"

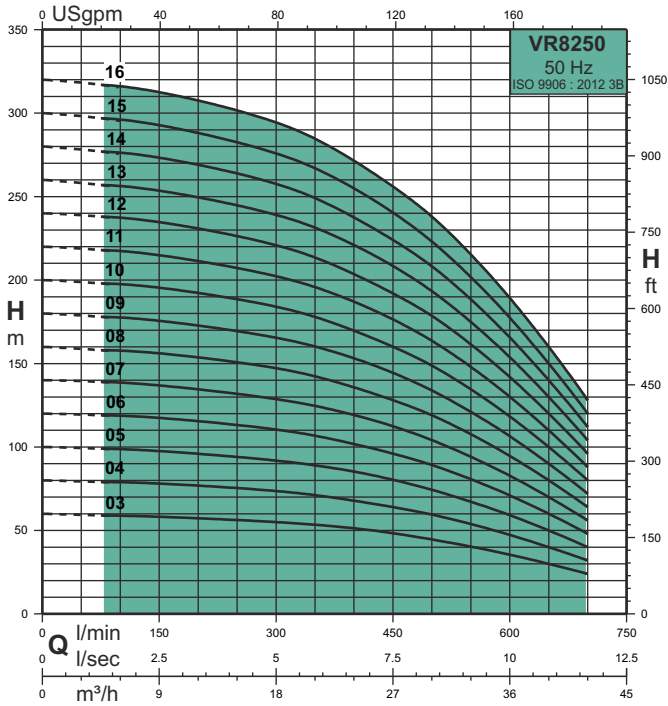

Pump type	P <sub>2</sub>		Q m <sup>3</sup> /h							
	kW	HP	0	20,1	25,5	29,7	35,7	39,0	42,0	
VR8250-03	5,5	7,5	60	54	50	45	36	30	24	
VR8250-04	7,5	10	80	72	66	60	48	40	32	
VR8250-05	9,3	12,5	100	90	83	75	60	50	40	
VR8250-06	11	15	120	108	99	90	72	60	48	
VR8250-07	13	17,5	140	126	116	105	84	70	56	
VR8250-08	15	20	160	144	132	120	96	80	64	
VR8250-09	18,5	25	180	162	149	135	108	90	72	
VR8250-10	18,5	25	200	180	165	150	120	100	80	
VR8250-11	22	30	220	198	182	165	132	110	88	
VR8250-12	22	30	240	216	198	180	144	120	96	
VR8250-13	26	35	260	234	215	195	156	130	104	
VR8250-14	26	35	280	252	231	210	168	140	112	
VR8250-15	30	40	300	270	248	225	180	150	120	
VR8250-16	30	40	320	288	264	240	192	160	128	

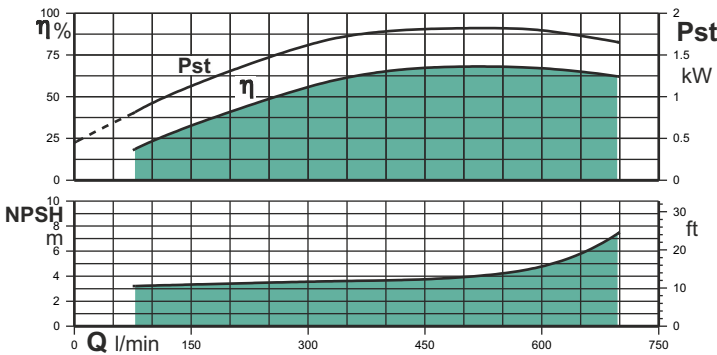

Nominal flow rate	495 l/min
Flow range	75 - 700 l/min
Head range	Up to 600 metres
Max. pump efficiency (η)	68%
Motor power	5,5 - 55 kW
Rated speed	2900 rpm
Pipe connection	G 3

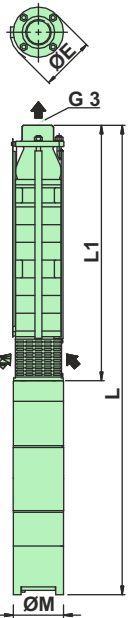

Pump type	P <sub>2</sub>		Dimensions						Gross weight [kg]			Gross volume [m <sup>3</sup> ]		
			L1 [mm]	ØE [mm]	WF motor				Pump	Pump + WF		Pump	Pump + WF	
					Size	ØM [mm]	L [mm]			1 ~	3 ~		1 ~	3 ~
							1 ~	3 ~						
VR8250-03	5,5	7,5	589	198	6"	142	-	1297	57,0	-	117,2	0,0840	-	0,1400
VR8250-04	7,5	10	634	198	6"	142	-	1392	62,0	-	127,5	0,0840	-	0,1400
VR8250-05	9,3	12,5	678	198	6"	142	-	1476	70,0	-	139,4	0,0880	-	0,1440
VR8250-06	11	15	723	198	6"	142	-	1556	74,0	-	147,6	0,0880	-	0,1440
VR8250-07	13	17,5	767	198	6"	142	-	1630	80,0	-	156,0	0,0960	-	0,1520
VR8250-08	15	20	812	198	6"	142	-	1745	85,0	-	169,4	0,0960	-	0,1620
VR8250-09	18,5	25	856	198	6"	142	-	1849	90,0	-	180,5	0,0960	-	0,1620
VR8250-10	18,5	25	989	198	6"	142	-	1982	104,0	-	194,5	0,1260	-	0,1920
VR8250-11	22	30	1034	198	6"	142	-	2087	108,0	-	207,0	0,1260	-	0,1920
VR8250-12	22	30	1078	198	6"	142	-	2131	113,0	-	212,0	0,1260	-	0,1920
VR8250-13	26	35	1123	198	6"	142	-	2256	118,0	-	231,5	0,1320	-	0,2650
VR8250-14	26	35	1167	198	6"	142	-	2300	124,0	-	237,5	0,1350	-	0,2680
VR8250-15	30	40	1212	198	6"	142	-	2395	130,0	-	255,0	0,1380	-	0,2710
VR8250-16	30	40	1256	198	6"	142	-	2439	136,0	-	261,0	0,1510	-	0,2840

**Note:** ØE = For single cable motor maximum diameter of pump inclusive of cable guard.  
For two cable motor maximum diameter of pump inclusive of cable guard will increase by 4 mm.  
All dimensions in mm unless otherwise noted.



# VR8250

## Radial Flow Pump Characteristic Curves & Technical Data

# 8"

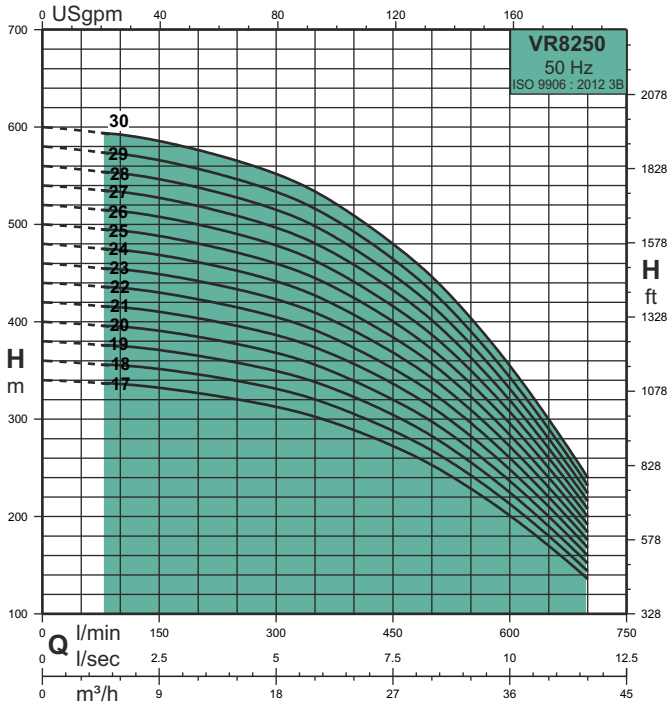

Pump type	P <sub>2</sub>		Q m <sup>3</sup> /h	0	20,1	25,5	29,7	35,7	39,0	42,0
	kW	HP								
VR8250-17	37	50	Q l/min	0	335	425	495	595	650	700
VR8250-18	37	50	H m	340	306	281	255	204	170	136
VR8250-19	37	50		360	324	297	270	216	180	144
VR8250-20	37	50		380	342	314	285	228	190	152
VR8250-21	45	60		400	360	330	300	240	200	160
VR8250-22	45	60		420	378	347	315	252	210	168
VR8250-23	45	60		440	396	363	330	264	220	176
VR8250-24	45	60		460	414	380	345	276	230	184
VR8250-25	55	75		480	432	396	360	288	240	192
VR8250-26	55	75		500	450	413	375	300	250	200
VR8250-27	55	75		520	468	429	390	312	260	208
VR8250-28	55	75		540	486	446	405	324	270	216
VR8250-29	55	75		560	504	462	420	336	280	224
VR8250-30	55	75		580	522	479	435	348	290	232
				600	540	495	450	360	300	240

Nominal flow rate	495 l/min
Flow range	75 - 700 l/min
Head range	Up to 600 metres
Max. pump efficiency (η)	68%
Motor power	5,5 - 55 kW
Rated speed	2900 rpm
Pipe connection	G 3

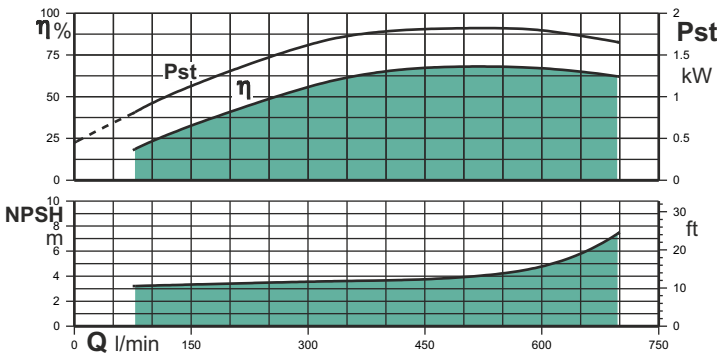
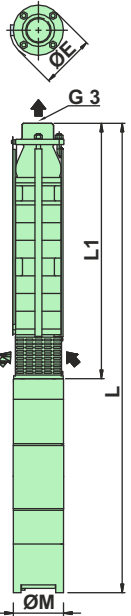

Pump type	P <sub>2</sub>		Dimensions						Gross weight [kg]			Gross volume [m <sup>3</sup> ]		
			L1 [mm]	ØE [mm]	WF motor				Pump	Pump + WF		Pump	Pump + WF	
					Size	ØM [mm]	L [mm]			1 ~	3 ~		1 ~	3 ~
							1 ~	3 ~						
VR8250-17	37	50	1390	198	6"	142	-	2703	141,0	-	276,0	0,1570	-	0,2970
VR8250-18	37	50	1435	198	6"	142	-	2748	147,0	-	282,0	0,1640	-	0,3040
VR8250-19	37	50	1479	198	6"	142	-	2792	153,0	-	288,0	0,1700	-	0,3100
VR8250-20	37	50	1524	198	6"	142	-	2837	159,0	-	294,0	0,1760	-	0,3160
VR8250-21	45	60	1568	198	8"	190	-	2778	163,0	-	377,0	0,1760	-	0,3890
VR8250-22	45	60	1613	198	8"	190	-	2823	167,0	-	381,0	0,1760	-	0,3890
VR8250-23	45	60	1657	198	8"	190	-	2867	172,0	-	386,0	0,1830	-	0,3960
VR8250-24	45	60	1702	198	8"	190	-	2912	178,0	-	392,0	0,1900	-	0,4030
VR8250-25	55	75	1746	198	8"	190	-	3006	184,0	-	412,0	0,1960	-	0,4164
VR8250-26	55	75	1791	198	8"	190	-	3051	190,0	-	418,0	0,2030	-	0,4234
VR8250-27	55	75	1835	198	8"	190	-	3095	195,0	-	423,0	0,2090	-	0,4294
VR8250-28	55	75	1880	198	8"	190	-	3140	201,0	-	429,0	0,2160	-	0,4364
VR8250-29	55	75	1927	198	8"	190	-	3187	205,0	-	433,0	0,2160	-	0,4364
VR8250-30	55	75	1968	198	8"	190	-	3228	209,0	-	437,0	0,2160	-	0,4364

**Note:** ØE = For single cable motor maximum diameter of pump inclusive of cable guard.  
For two cable motor maximum diameter of pump inclusive of cable guard will increase by 4 mm.  
All dimensions in mm unless otherwise noted.



# VR8300

## Radial Flow Pump Characteristic Curves & Technical Data

# 8"

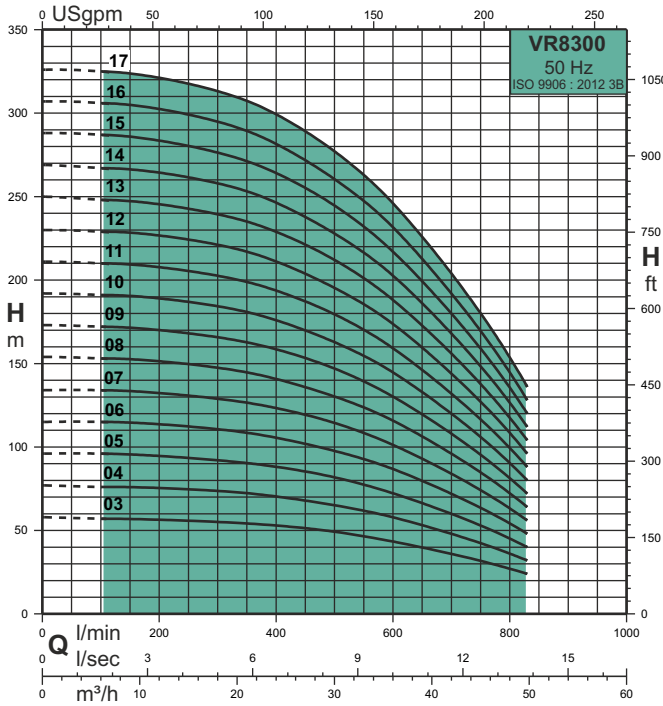

Pump type	P <sub>2</sub>		Q m <sup>3</sup> /h	0	21,6	29,1	34,5	42,0	46,0	49,8
	kW	HP								
VR8300-03	7,5	10	Q l/min	0	360	485	575	700	770	830
VR8300-04	9,3	12,5	58	54	50	45	36	30	24	
VR8300-05	11	15	77	72	66	60	48	40	32	
VR8300-06	13	17,5	96	90	83	75	60	50	40	
VR8300-07	18,5	25	115	108	99	90	72	60	48	
VR8300-08	18,5	25	134	126	116	105	84	70	56	
VR8300-09	22	30	154	144	132	120	96	80	64	
VR8300-10	22	30	173	162	149	135	108	90	72	
VR8300-11	26	35	192	180	165	150	120	100	80	
VR8300-12	26	35	211	198	182	165	132	110	88	
VR8300-13	30	40	230	216	198	180	144	120	96	
VR8300-14	37	50	250	234	215	195	156	130	104	
VR8300-15	37	50	269	252	231	210	168	140	112	
VR8300-16	37	50	288	270	248	225	180	150	120	
VR8300-17	45	60	307	288	264	240	192	160	128	
			326	306	281	255	204	170	136	

Nominal flow rate	575 l/min
Flow range	100 - 830 l/min
Head range	Up to 576 metres
Max. pump efficiency (η)	69%
Motor power	7,5 - 66 kW
Rated speed	2900 rpm
Pipe connection	G 3

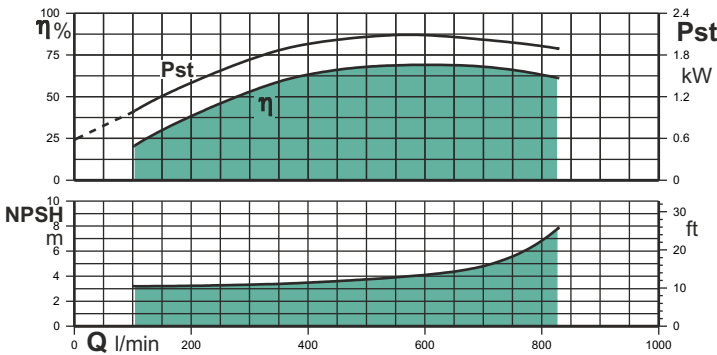
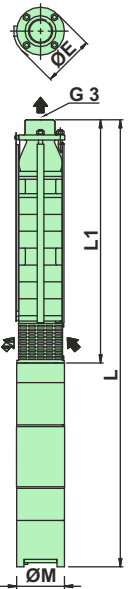

Pump type	P <sub>2</sub>		Dimensions						Gross weight [kg]			Gross volume [m <sup>3</sup> ]		
			L1 [mm]	ØE [mm]	WF motor				Pump	Pump + WFM		Pump	Pump + WFM	
					Size	ØM [mm]	L [mm]			1 ~	3 ~		1 ~	3 ~
							1 ~	3 ~						
VR8300-03	7,5	10	710	198	6"	142	-	1468	59,0	-	124,5	0,0880	-	0,1440
VR8300-04	9,3	12,5	775	198	6"	142	-	1573	70,0	-	139,4	0,0960	-	0,1520
VR8300-05	11	15	840	198	6"	142	-	1673	79,0	-	152,6	0,1030	-	0,1590
VR8300-06	13	17,5	905	198	6"	142	-	1768	91,0	-	167,0	0,1130	-	0,1690
VR8300-07	18,5	25	970	198	6"	142	-	1963	99,0	-	189,5	0,1130	-	0,1790
VR8300-08	18,5	25	1035	198	6"	142	-	2028	109,0	-	199,5	0,1260	-	0,1920
VR8300-09	22	30	1189	198	6"	142	-	2242	126,0	-	225,0	0,1380	-	0,2040
VR8300-10	22	30	1254	198	6"	142	-	2307	138,0	-	237,0	0,1510	-	0,2170
VR8300-11	26	35	1319	198	6"	142	-	2452	148,0	-	261,5	0,1570	-	0,2900
VR8300-12	26	35	1384	198	6"	142	-	2517	158,0	-	271,5	0,1640	-	0,2970
VR8300-13	30	40	1449	198	6"	142	-	2632	168,0	-	293,0	0,1700	-	0,3030
VR8300-14	37	50	1514	198	6"	142	-	2827	178,0	-	313,0	0,1760	-	0,3160
VR8300-15	37	50	1579	198	6"	142	-	2892	186,0	-	321,0	0,1760	-	0,3160
VR8300-16	37	50	1644	198	6"	142	-	2957	200,0	-	335,0	0,1890	-	0,3290
VR8300-17	45	60	1798	198	8"	190	-	3008	214,0	-	428,0	0,2030	-	0,4160

**Note:** ØE = For single cable motor maximum diameter of pump inclusive of cable guard.  
For two cable motor maximum diameter of pump inclusive of cable guard will increase by 4 mm.  
All dimensions in mm unless otherwise noted.





# VR8300

## Radial Flow Pump Characteristic Curves & Technical Data

# 8"

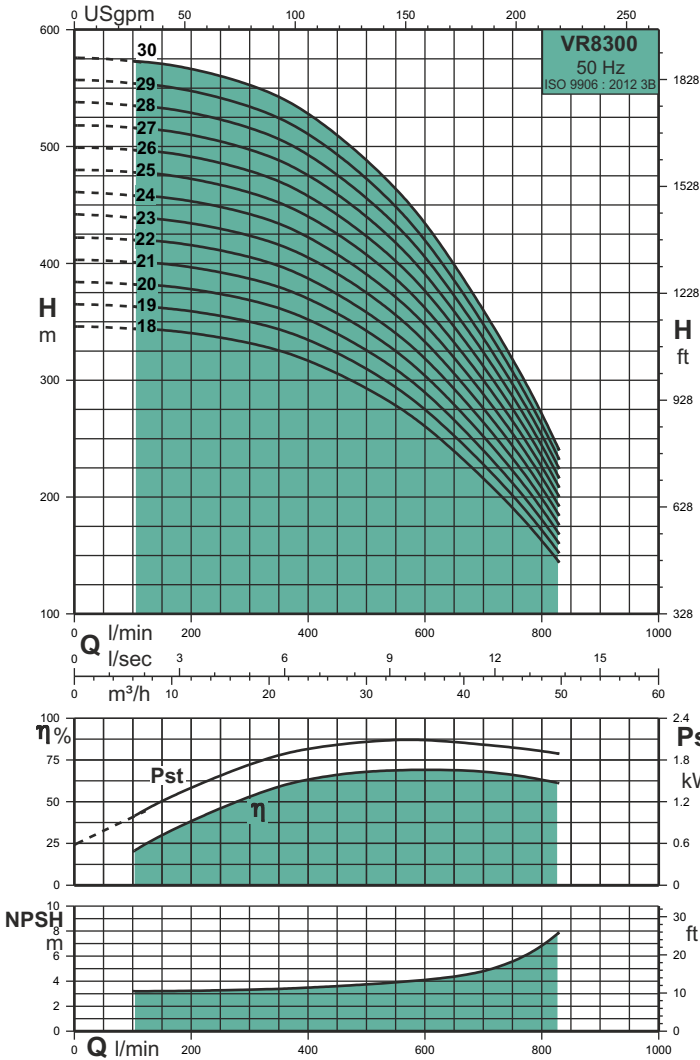

Pump type	P <sub>2</sub>		Q m <sup>3</sup> /h	0	21,6	29,1	34,5	42,0	46,0	49,8
	kW	HP		Q l/min	0	360	485	575	700	770
VR8300-18	45	60	H m	346	324	297	270	216	180	144
VR8300-19	45	60		365	342	314	285	228	190	152
VR8300-20	45	60		384	360	330	300	240	200	160
VR8300-21	55	75		403	378	347	315	252	210	168
VR8300-22	55	75		422	396	363	330	264	220	176
VR8300-23	55	75		442	414	380	345	276	230	184
VR8300-24	55	75		461	432	396	360	288	240	192
VR8300-25	55	75		480	450	413	375	300	250	200
VR8300-26	66	90		499	468	429	390	312	260	208
VR8300-27	66	90		518	486	446	405	324	270	216
VR8300-28	66	90		538	504	462	420	336	280	224
VR8300-29	66	90		557	522	479	435	348	290	232
VR8300-30	66	90	576	540	495	450	360	300	240	

Nominal flow rate	575 l/min
Flow range	100 - 830 l/min
Head range	Up to 576 metres
Max. pump efficiency (η)	69%
Motor power	7,5 - 66 kW
Rated speed	2900 rpm
Pipe connection	G 3

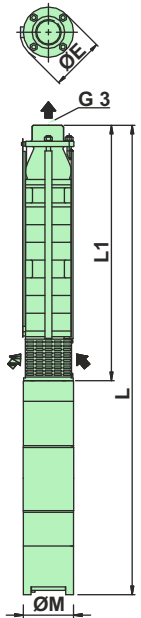

Pump type	P <sub>2</sub>		Dimensions						Gross weight [kg]			Gross volume [m <sup>3</sup> ]		
			L1 [mm]	ØE [mm]	WF motor				Pump	Pump + WF		Pump	Pump + WF	
					Size	ØM [mm]	L [mm]			1 ~	3 ~		1 ~	3 ~
							1 ~	3 ~						
VR8300-18	45	60	1863	198	8"	190	-	3073	224,0	-	438,0	0,2090	-	0,4220
VR8300-19	45	60	1928	198	8"	190	-	3138	234,0	-	448,0	0,2160	-	0,4290
VR8300-20	45	60	1993	198	8"	190	-	3203	245,0	-	459,0	0,2280	-	0,4410
VR8300-21	55	75	2058	198	8"	190	-	3318	254,0	-	482,0	0,2330	-	0,4534
VR8300-22	55	75	2123	198	8"	190	-	3383	263,0	-	491,0	0,2380	-	0,4584
VR8300-23	55	75	2188	198	8"	190	-	3448	272,0	-	500,0	0,2430	-	0,4634
VR8300-24	55	75	2253	198	8"	190	-	3513	282,0	-	510,0	0,2480	-	0,4684
VR8300-25	55	75	2318	198	8"	190	-	3578	293,0	-	521,0	0,2540	-	0,4744
VR8300-26	66	90	2383	198	8"	190	-	3810	303,0	-	570,0	0,2610	-	0,5040
VR8300-27	66	90	2448	198	8"	190	-	3875	313,0	-	580,0	0,2690	-	0,5120
VR8300-28	66	90	2513	198	8"	190	-	3940	323,0	-	590,0	0,2760	-	0,5190
VR8300-29	66	90	2578	198	8"	190	-	4005	333,0	-	600,0	0,2840	-	0,5270
VR8300-30	66	90	2643	198	8"	190	-	4070	344,0	-	611,0	0,2920	-	0,5350

**Note:** ØE = For single cable motor maximum diameter of pump inclusive of cable guard.  
For two cable motor maximum diameter of pump inclusive of cable guard will increase by 4 mm.  
All dimensions in mm unless otherwise noted.



# VR8400

## Radial Flow Pump Characteristic Curves & Technical Data

# 8"

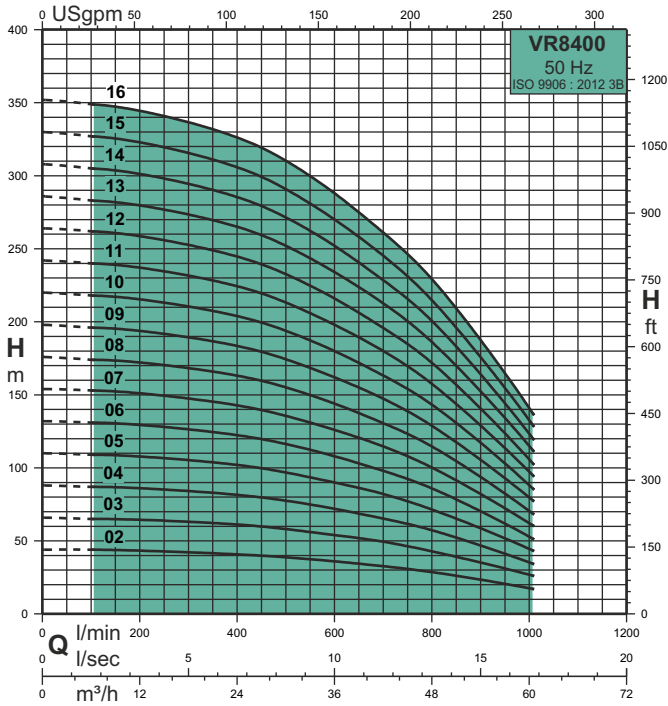

Pump type	P <sub>2</sub>		Q m <sup>3</sup> /h	0	26,7	36,0	41,4	46,2	53,4	60,6
	kW	HP								
VR8400-02	7,5	10	Q l/min	0	445	600	690	770	890	1010
VR8400-03	9,3	12,5	44	40	36	33	30	24	17	
VR8400-04	15	20	66	60	54	50	45	36	26	
VR8400-05	15	20	88	80	72	66	60	48	34	
VR8400-06	18,5	25	110	100	90	83	75	60	43	
VR8400-07	22	30	132	120	108	99	90	72	51	
VR8400-08	26	35	154	140	126	116	105	84	60	
VR8400-09	30	40	176	160	144	132	120	96	68	
VR8400-10	30	40	198	180	162	149	135	108	77	
VR8400-11	37	50	220	200	180	165	150	120	85	
VR8400-12	37	50	242	220	198	182	165	132	94	
VR8400-13	45	60	264	240	216	198	180	144	102	
VR8400-14	45	60	286	260	234	215	195	156	111	
VR8400-15	45	60	308	280	252	231	210	168	119	
VR8400-16	55	75	330	300	270	248	225	180	128	
			352	320	288	264	240	192	136	

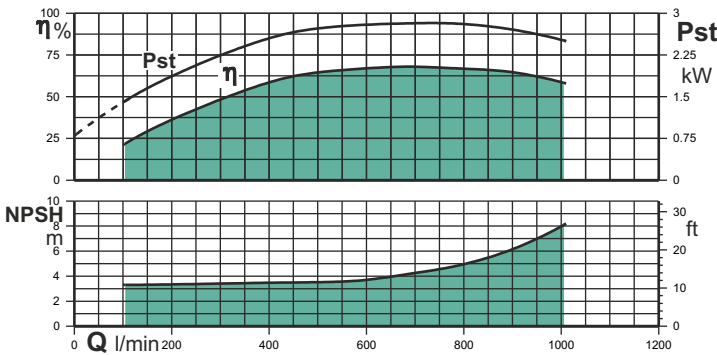

Nominal flow rate	770 l/min
Flow range	100 - 1010 l/min
Head range	Up to 660 metres
Max. pump efficiency (η)	68%
Motor power	7,5 - 93 kW
Rated speed	2900 rpm
Pipe connection	G 3

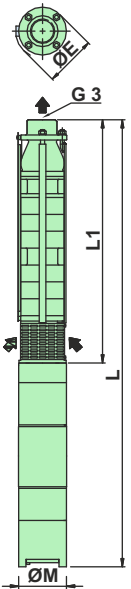

Pump type	P <sub>2</sub>		Dimensions						Gross weight [kg]			Gross volume [m <sup>3</sup> ]		
			L1 [mm]	ØE [mm]	WF motor				Pump	Pump + WFM		Pump	Pump + WFM	
					Size	ØM [mm]	L [mm]			1 ~	3 ~		1 ~	3 ~
							1 ~	3 ~						
VR8400-02	7,5	10	645	198	6"	142	-	1403	46,0	-	111,5	0,0840	-	0,1400
VR8400-03	9,3	12,5	710	198	6"	142	-	1508	59,0	-	128,4	0,0880	-	0,1440
VR8400-04	15	20	775	198	6"	142	-	1708	70,0	-	154,4	0,0960	-	0,1620
VR8400-05	15	20	840	198	6"	142	-	1773	79,0	-	163,4	0,1030	-	0,1690
VR8400-06	18,5	25	905	198	6"	142	-	1898	91,0	-	181,5	0,1130	-	0,1790
VR8400-07	22	30	970	198	6"	142	-	2023	99,0	-	198,0	0,1130	-	0,1790
VR8400-08	26	35	1035	198	6"	142	-	2168	109,0	-	222,5	0,1260	-	0,2590
VR8400-09	30	40	1189	198	6"	142	-	2372	126,0	-	251,0	0,1380	-	0,2710
VR8400-10	30	40	1254	198	6"	142	-	2437	138,0	-	263,0	0,1510	-	0,2840
VR8400-11	37	50	1319	198	6"	142	-	2632	148,0	-	283,0	0,1570	-	0,2970
VR8400-12	37	50	1384	198	6"	142	-	2697	158,0	-	293,0	0,1640	-	0,3040
VR8400-13	45	60	1449	198	8"	190	-	2659	168,0	-	382,0	0,1700	-	0,3830
VR8400-14	45	60	1514	198	8"	190	-	2724	178,0	-	392,0	0,1760	-	0,3890
VR8400-15	45	60	1579	198	8"	190	-	2789	186,0	-	400,0	0,1760	-	0,3890
VR8400-16	55	75	1644	198	8"	190	-	2904	200,0	-	428,0	0,1890	-	0,4094

**Note:** ØE = For single cable motor maximum diameter of pump inclusive of cable guard.  
For two cable motor maximum diameter of pump inclusive of cable guard will increase by 4 mm.  
All dimensions in mm unless otherwise noted.



# VR8400

## Radial Flow Pump Characteristic Curves & Technical Data

# 8"

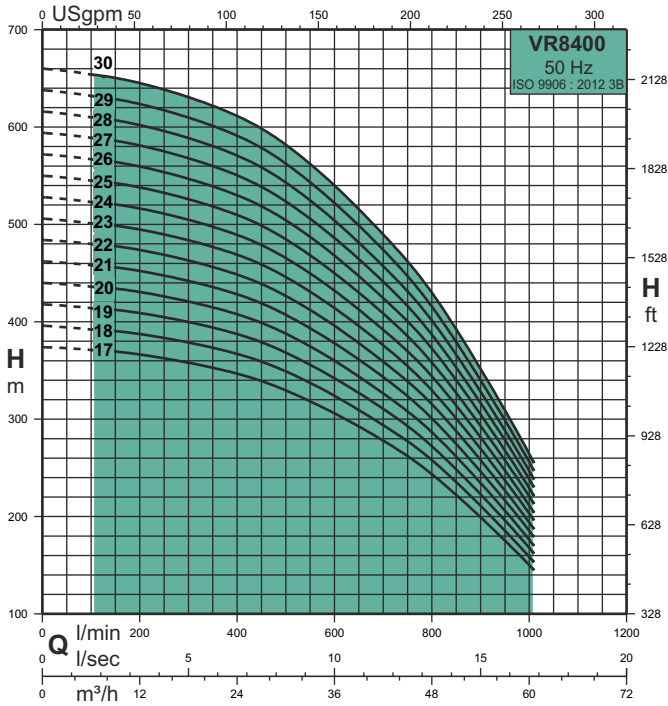

Pump type	P <sub>2</sub>		Q m <sup>3</sup> /h	0	26,7	36,0	41,4	46,2	53,4	60,6
	kW	HP								
VR8400-17	55	75	Q l/min	0	445	600	690	770	890	1010
VR8400-18	55	75	374	340	306	281	255	204	145	
VR8400-19	55	75	396	360	324	297	270	216	153	
VR8400-20	55	75	418	380	342	314	285	228	162	
VR8400-21	66	90	440	400	360	330	300	240	170	
VR8400-22	66	90	462	420	378	347	315	252	179	
VR8400-23	75	100	484	440	396	363	330	264	187	
VR8400-24	75	100	506	460	414	380	345	276	196	
VR8400-25	75	100	528	480	432	396	360	288	204	
VR8400-26	93	125	550	500	450	413	375	300	213	
VR8400-27	93	125	572	520	468	429	390	312	221	
VR8400-28	93	125	594	540	486	446	405	324	230	
VR8400-29	93	125	616	560	504	462	420	336	238	
VR8400-30	93	125	638	580	522	479	435	348	247	
			660	600	540	495	450	360	255	

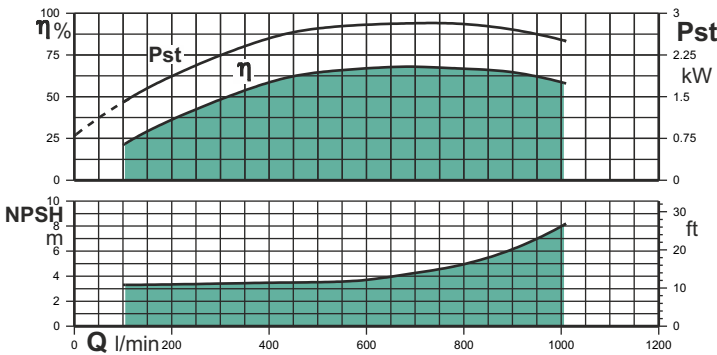

Nominal flow rate	770 l/min
Flow range	100 - 1010 l/min
Head range	Up to 660 metres
Max. pump efficiency (η)	68%
Motor power	7,5 - 93 kW
Rated speed	2900 rpm
Pipe connection	G 3

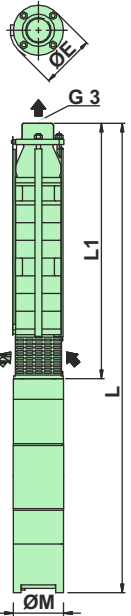

Pump type	P <sub>2</sub>		Dimensions						Gross weight [kg]			Gross volume [m <sup>3</sup> ]		
			L1 [mm]	ØE [mm]	WF motor				Pump	Pump + WFM		Pump	Pump + WFM	
					Size	ØM [mm]	L [mm]			1 ~	3 ~		1 ~	3 ~
							1 ~	3 ~						
VR8400-17	55	75	1798	198	8"	190	-	3058	214,0	-	442,0	0,2030	-	0,4234
VR8400-18	55	75	1863	198	8"	190	-	3123	224,0	-	452,0	0,2090	-	0,4294
VR8400-19	55	75	1928	198	8"	190	-	3188	234,0	-	462,0	0,2160	-	0,4364
VR8400-20	55	75	1993	198	8"	190	-	3253	245,0	-	473,0	0,2280	-	0,4484
VR8400-21	66	90	2058	198	8"	190	-	3485	254,0	-	521,0	0,2330	-	0,4760
VR8400-22	66	90	2123	198	8"	190	-	3550	263,0	-	530,0	0,2380	-	0,4810
VR8400-23	75	100	2188	198	8"	190	-	3665	272,0	-	550,0	0,2430	-	0,4933
VR8400-24	75	100	2253	198	8"	190	-	3730	282,0	-	560,0	0,2480	-	0,4983
VR8400-25	75	100	2318	198	8"	190	-	3795	293,0	-	571,0	0,2540	-	0,5043
VR8400-26	93	125	2383	198	8"	190	-	4000	303,0	-	608,0	0,2610	-	0,5300
VR8400-27	93	125	2448	198	8"	190	-	4065	313,0	-	618,0	0,2690	-	0,5380
VR8400-28	93	125	2513	198	8"	190	-	4130	323,0	-	628,0	0,2760	-	0,5450
VR8400-29	93	125	2578	198	8"	190	-	4195	333,0	-	638,0	0,2840	-	0,5530
VR8400-30	93	125	2643	198	8"	190	-	4260	344,0	-	649,0	0,2920	-	0,5610

**Note:** ØE = For single cable motor maximum diameter of pump inclusive of cable guard.  
For two cable motor maximum diameter of pump inclusive of cable guard will increase by 4 mm.  
All dimensions in mm unless otherwise noted.



# VR8500

## Radial Flow Pump Characteristic Curves & Technical Data

# 8"

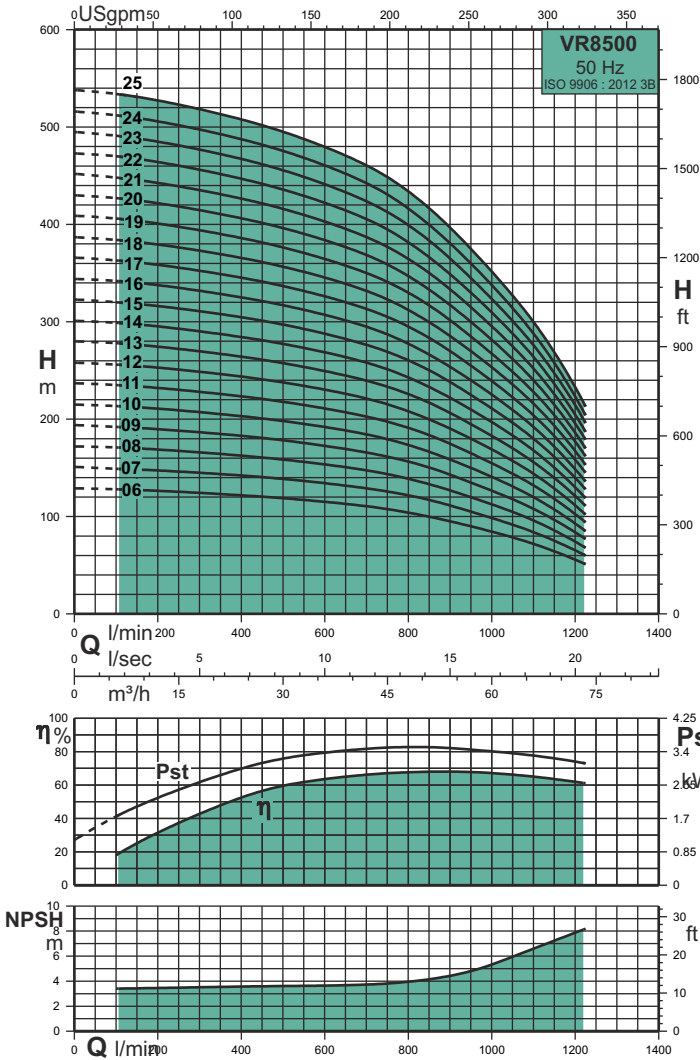

Pump type	P <sub>2</sub>		Q m <sup>3</sup> /h	0	27,9	44,7	51,6	57,0	66,0	73,5
	kW	HP		Q l/min	0	465	745	860	950	1100
VR8500-06	22	30	H m	129	120	108	99	90	72	51
VR8500-07	26	35		151	140	126	116	105	84	60
VR8500-08	30	40		172	160	144	132	120	96	68
VR8500-09	37	50		194	180	162	149	135	108	77
VR8500-10	37	50		215	200	180	165	150	120	85
VR8500-11	45	60		237	220	198	182	165	132	94
VR8500-12	45	60		258	240	216	198	180	144	102
VR8500-13	55	75		280	260	234	215	195	156	111
VR8500-14	55	75		301	280	252	231	210	168	119
VR8500-15	55	75		323	300	270	248	225	180	128
VR8500-16	55	75		344	320	288	264	240	192	136
VR8500-17	66	90		366	340	306	281	255	204	145
VR8500-18	66	90		387	360	324	297	270	216	153
VR8500-19	75	100		409	380	342	314	285	228	162
VR8500-20	75	100		430	400	360	330	300	240	170
VR8500-21	93	125		452	420	378	347	315	252	179
VR8500-22	93	125		473	440	396	363	330	264	187
VR8500-23	93	125		495	460	414	380	345	276	196
VR8500-24	93	125		516	480	432	396	360	288	204
VR8500-25	93	125		538	500	450	413	375	300	213

Nominal flow rate	950 l/min
Flow range	100 - 1225 l/min
Head range	Up to 538 metres
Max. pump efficiency (η)	68%
Motor power	22 - 93 kW
Rated speed	2900 rpm
Pipe connection	G 3

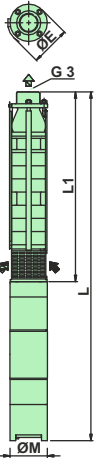

Pump type	P <sub>2</sub>		Dimensions						Gross weight [kg]			Gross volume [m <sup>3</sup> ]		
			L1 [mm]	ØE [mm]	WF motor				Pump	Pump + WFM		Pump	Pump + WFM	
					Size	ØM [mm]	L [mm]			1 ~	3 ~		1 ~	3 ~
							1 ~	3 ~						
VR8500-06	22	30	968	198	6"	142	-	2021	82,0	-	181,0	0,1130	-	0,1790
VR8500-07	26	35	1038	198	6"	142	-	2171	89,0	-	202,5	0,1260	-	0,2590
VR8500-08	30	40	1120	198	6"	142	-	2303	97,0	-	222,0	0,1380	-	0,2710
VR8500-09	37	50	1190	198	6"	142	-	2503	108,0	-	243,0	0,1380	-	0,2780
VR8500-10	37	50	1260	198	6"	142	-	2573	115,0	-	250,0	0,1440	-	0,2840
VR8500-11	45	60	1330	198	8"	190	-	2540	122,0	-	336,0	0,1510	-	0,3640
VR8500-12	45	60	1400	198	8"	190	-	2610	128,0	-	342,0	0,1570	-	0,3700
VR8500-13	55	75	1470	198	8"	190	-	2730	135,0	-	363,0	0,1640	-	0,3844
VR8500-14	55	75	1540	198	8"	190	-	2800	141,0	-	369,0	0,1700	-	0,3904
VR8500-15	55	75	1610	198	8"	190	-	2870	148,0	-	376,0	0,1760	-	0,3964
VR8500-16	55	75	1680	198	8"	190	-	2940	159,0	-	387,0	0,1890	-	0,4094
VR8500-17	66	90	1750	198	8"	190	-	3177	170,0	-	437,0	0,2030	-	0,4460
VR8500-19	66	90	1820	198	8"	190	-	3247	176,0	-	443,0	0,2090	-	0,4520
VR8500-20	75	100	1890	198	8"	190	-	3367	183,0	-	461,0	0,2160	-	0,4663
VR8500-21	75	100	1960	198	8"	190	-	3437	190,0	-	468,0	0,2180	-	0,4683
VR8500-22	93	125	2132	198	8"	190	-	3749	199,0	-	504,0	0,2410	-	0,5100
VR8500-23	93	125	2202	198	8"	190	-	3819	205,0	-	510,0	0,2470	-	0,5160
VR8500-24	93	125	2272	198	8"	190	-	3889	212,0	-	517,0	0,2540	-	0,5230
VR8500-25	93	125	2342	198	8"	190	-	3959	218,0	-	523,0	0,2600	-	0,5290
	93	125	2412	198	8"	190	-	4029	225,0	-	530,0	0,2660	-	0,5350

**Note:** ØE = For single cable motor maximum diameter of pump inclusive of cable guard.  
For two cable motor maximum diameter of pump inclusive of cable guard will increase by 4 mm.

All dimensions in mm unless otherwise noted.



# VM8040

## Mixed Flow Pump Characteristic Curves & Technical Data

# 8"

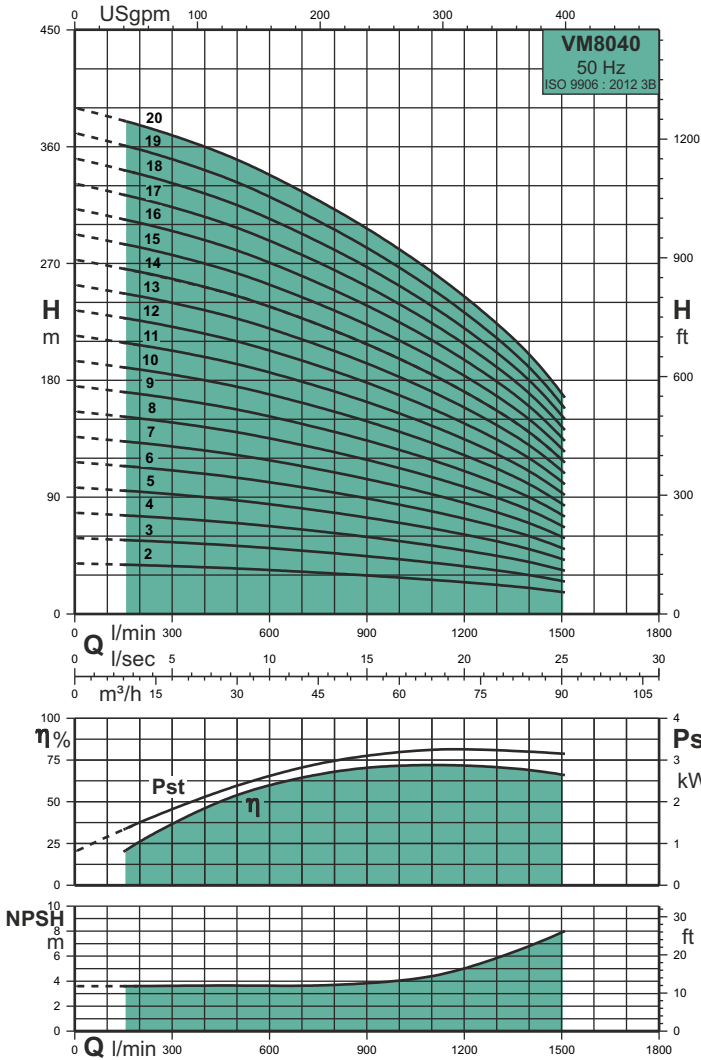

Pump type	P <sub>2</sub>		Q m <sup>3</sup> /h							
	kW	HP	0	30,0	44,4	52,8	67,2	84,0	90,6	
VM8040-02	7,5	10	39	35	32	30	26	20	17	
VM8040-03	9,3	12,5	59	53	48	45	39	30	25	
VM8040-04	15	20	78	70	64	60	52	40	33	
VM8040-05	15	20	98	88	80	75	65	50	42	
VM8040-06	18,5	25	117	105	96	90	78	60	50	
VM8040-07	22	30	137	123	112	105	91	70	58	
VM8040-08	26	35	156	140	128	120	104	80	67	
VM8040-09	30	40	176	158	144	135	117	90	75	
VM8040-10	30	40	195	175	160	150	130	100	83	
VM8040-11	37	50	215	193	176	165	143	110	92	
VM8040-12	37	50	234	210	192	180	156	120	100	
VM8040-13	45	60	254	228	208	195	169	130	108	
VM8040-14	45	60	273	245	224	210	182	140	117	
VM8040-15	45	60	293	263	240	225	195	150	125	
VM8040-16	55	75	312	280	256	240	208	160	133	
VM8040-17	55	75	332	298	272	255	221	170	142	
VM8040-18	55	75	351	315	288	270	234	180	150	
VM8040-19	55	75	371	333	304	285	247	190	158	
VM8040-20	55	75	390	350	320	300	260	200	167	

Nominal flow rate	880 l/min
Flow range	150 - 1510 l/min
Head range	Up to 350 metres
Max. pump efficiency (η)	72%
Motor power	7,5 - 55 kW
Rated speed	2900 rpm
Pipe connection	G 4

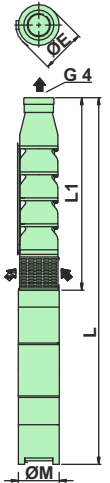

Pump type	P <sub>2</sub>		Dimensions						Gross weight [kg]			Gross volume [m <sup>3</sup> ]		
			L1 [mm]	ØE [mm]	WF motor				Pump	Pump + WFM		Pump	Pump + WFM	
					Size	ØM [mm]	L [mm]			1 ~	3 ~		1 ~	3 ~
							1 ~	3 ~						
VM8040-02	7,5	10	593	196	6"	142	-	1351	51,0	-	116,5	0,0650	-	0,1210
VM8040-03	9,3	12,5	713	196	6"	142	-	1511	67,0	-	136,4	0,0880	-	0,1440
VM8040-04	15	20	833	196	6"	142	-	1766	81,0	-	165,4	0,1030	-	0,1690
VM8040-05	15	20	953	196	6"	142	-	1886	94,0	-	178,4	0,1130	-	0,1790
VM8040-06	18,5	25	1073	196	6"	142	-	2066	107,0	-	197,5	0,1260	-	0,1920
VM8040-07	22	30	1193	196	6"	142	-	2246	120,0	-	219,0	0,1380	-	0,2040
VM8040-08	26	35	1313	196	6"	142	-	2446	135,0	-	248,5	0,1510	-	0,2840
VM8040-09	30	40	1433	196	6"	142	-	2616	149,0	-	274,0	0,1640	-	0,2970
VM8040-10	30	40	1553	196	6"	142	-	2736	162,0	-	287,0	0,1760	-	0,3090
VM8040-11	37	50	1673	196	6"	142	-	2986	171,0	-	306,0	0,1830	-	0,3230
VM8040-12	37	50	1793	196	6"	142	-	3106	181,0	-	316,0	0,1900	-	0,3300
VM8040-13	45	60	1913	196	8"	190	-	3123	190,0	-	404,0	0,1980	-	0,4110
VM8040-14	45	60	2033	196	8"	190	-	3243	200,0	-	414,0	0,2070	-	0,4200
VM8040-15	45	60	2153	196	8"	190	-	3363	210,0	-	424,0	0,2160	-	0,4290
VM8040-16	55	75	2273	196	8"	190	-	3533	233,0	-	461,0	0,2410	-	0,4614
VM8040-17	55	75	2393	196	8"	190	-	3653	257,0	-	485,0	0,2660	-	0,4864
VM8040-18	55	75	2513	196	8"	190	-	3773	271,0	-	499,0	0,2790	-	0,4994
VM8040-19	55	75	2633	196	8"	190	-	3893	285,0	-	513,0	0,2920	-	0,5124
VM8040-20	55	75	2753	196	8"	190	-	4013	297,0	-	525,0	0,3020	-	0,5224

**Note:** ØE = For single cable motor maximum diameter of pump inclusive of cable guard.  
For two cable motor maximum diameter of pump inclusive of cable guard will increase by 4 mm.  
All dimensions in mm unless otherwise noted.





# VM8050

## Mixed Flow Pump Characteristic Curves & Technical Data

# 8"

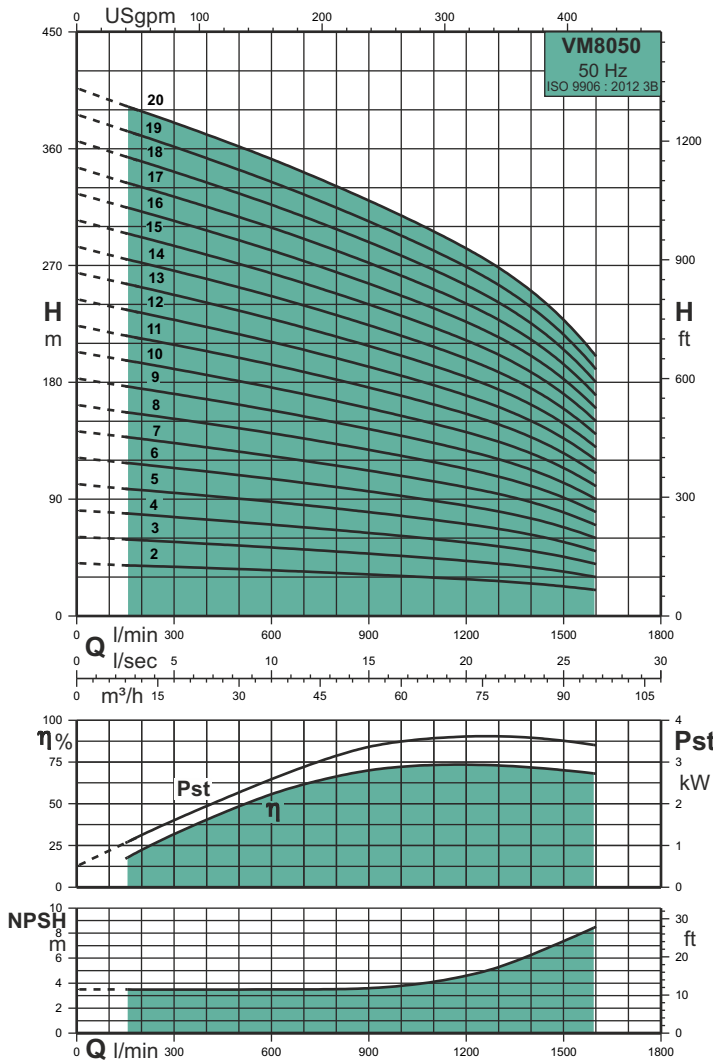

Pump type	P <sub>2</sub>		Q m <sup>3</sup> /h	Q l/min							
	kW	HP		0	37,2	54,0	64,2	77,4	87,0	96,0	
VM8050-02	7,5	10	41	35	32	30	27	24	20		
VM8050-03	11	15	61	53	48	45	41	36	30		
VM8050-04	15	20	81	70	64	60	54	48	40		
VM8050-05	18,5	25	102	88	80	75	68	60	50		
VM8050-06	22	30	122	105	96	90	81	72	60		
VM8050-07	26	35	142	123	112	105	95	84	70		
VM8050-08	30	40	163	140	128	120	108	96	80		
VM8050-09	37	50	183	158	144	135	122	108	90		
VM8050-10	37	50	203	175	160	150	135	120	100		
VM8050-11	45	60	224	193	176	165	149	132	110		
VM8050-12	45	60	244	210	192	180	162	144	120		
VM8050-13	55	75	264	228	208	195	176	156	130		
VM8050-14	55	75	285	245	224	210	189	168	140		
VM8050-15	55	75	305	263	240	225	203	180	150		
VM8050-16	55	75	325	280	256	240	216	192	160		
VM8050-17	66	90	346	298	272	255	230	204	170		
VM8050-18	66	90	366	315	288	270	243	216	180		
VM8050-19	75	100	386	333	304	285	257	228	190		
VM8050-20	75	100	407	350	320	300	270	240	200		

Nominal flow rate	1070 l/min
Flow range	150 - 1600 l/min
Head range	Up to 407 metres
Max. pump efficiency (η)	73%
Motor power	7,5 - 75 kW
Rated speed	2900 rpm
Pipe connection	G 4

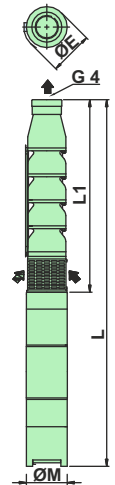

Pump type	P <sub>2</sub>		Dimensions						Gross weight [kg]			Gross volume [m <sup>3</sup> ]		
			L1 [mm]	ØE [mm]	WF motor				Pump	Pump + WFM		Pump	Pump + WFM	
					Size	ØM [mm]	L [mm]			1 ~	3 ~		1 ~	3 ~
							1 ~	3 ~						
VM8050-02	7,5	10	613	196	6"	142	-	1371	61,0	-	126,5	0,0880	-	0,1440
VM8050-03	11	15	743	196	6"	142	-	1576	79,0	-	152,6	0,0960	-	0,1520
VM8050-04	15	20	873	196	6"	142	-	1806	92,0	-	176,4	0,1030	-	0,1690
VM8050-05	18,5	25	1003	196	6"	142	-	1996	108,0	-	198,5	0,1260	-	0,1920
VM8050-06	22	30	1133	196	6"	142	-	2186	123,0	-	222,0	0,1380	-	0,2040
VM8050-07	26	35	1263	196	6"	142	-	2396	138,0	-	251,5	0,1510	-	0,2840
VM8050-08	30	40	1393	196	6"	142	-	2576	153,0	-	278,0	0,1640	-	0,2970
VM8050-09	37	50	1523	196	6"	142	-	2836	168,0	-	303,0	0,1760	-	0,3160
VM8050-10	37	50	1653	196	6"	142	-	2966	182,0	-	317,0	0,1900	-	0,3300
VM8050-11	45	60	1783	196	8"	190	-	2993	197,0	-	411,0	0,2030	-	0,4160
VM8050-12	45	60	1913	196	8"	190	-	3123	212,0	-	426,0	0,2160	-	0,4290
VM8050-13	55	75	2043	196	8"	190	-	3303	227,0	-	455,0	0,2280	-	0,4484
VM8050-14	55	75	2173	196	8"	190	-	3433	241,0	-	469,0	0,2410	-	0,4614
VM8050-15	55	75	2303	196	8"	190	-	3563	254,0	-	482,0	0,2470	-	0,4674
VM8050-16	55	75	2433	196	8"	190	-	3693	267,0	-	495,0	0,2540	-	0,4744
VM8050-17	66	90	2563	196	8"	190	-	3990	273,0	-	540,0	0,2610	-	0,5040
VM8050-18	66	90	2693	196	8"	190	-	4120	285,0	-	552,0	0,2680	-	0,5110
VM8050-19	75	100	2823	196	8"	190	-	4300	297,0	-	575,0	0,2750	-	0,5253
VM8050-20	75	100	2953	196	8"	190	-	4430	310,0	-	588,0	0,2820	-	0,5323

**Note:** ØE = For single cable motor maximum diameter of pump inclusive of cable guard.  
For two cable motor maximum diameter of pump inclusive of cable guard will increase by 4 mm.  
All dimensions in mm unless otherwise noted.



# VM8060

## Mixed Flow Pump Characteristic Curves & Technical Data

# 8"

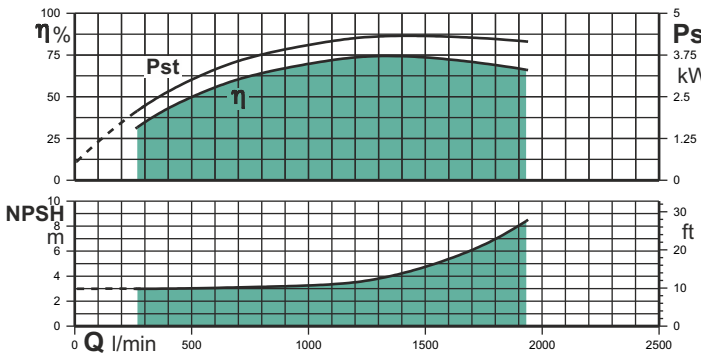
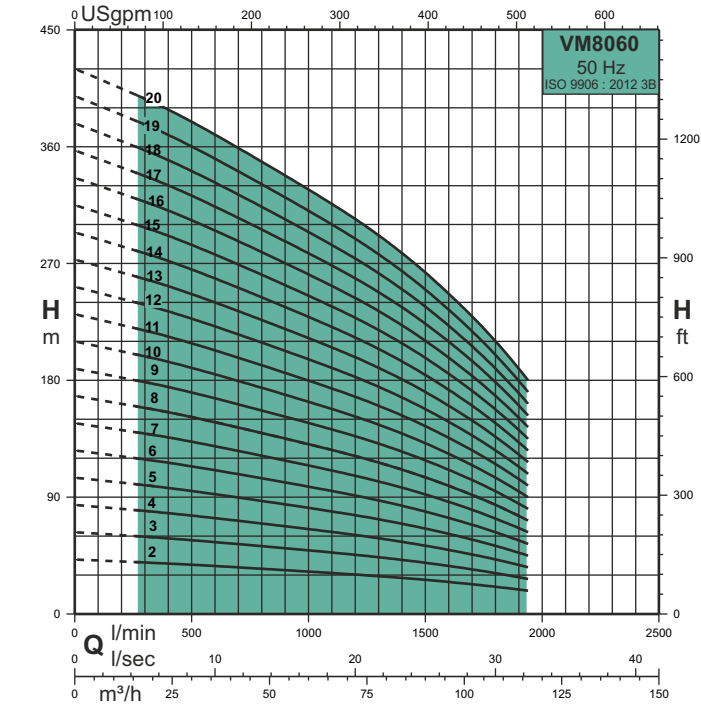

Pump type	P <sub>2</sub>		Q m <sup>3</sup> /h							
	kW	HP	0	26,6	40,8	74,4	87,0	105,0	116,4	
VM8060-02	9,3	12,5	42	39	36	30	27	22	18	
VM8060-03	15	20	63	59	54	45	41	33	27	
VM8060-04	18,5	25	84	78	72	60	54	44	36	
VM8060-05	22	30	105	98	90	75	68	55	45	
VM8060-06	30	40	126	118	108	90	81	66	54	
VM8060-07	37	50	147	137	126	105	95	77	63	
VM8060-08	37	50	168	157	144	120	108	88	72	
VM8060-09	45	60	189	176	162	135	122	99	81	
VM8060-10	45	60	210	196	180	150	135	110	90	
VM8060-11	55	75	231	216	198	165	149	121	99	
VM8060-12	55	75	252	235	216	180	162	132	108	
VM8060-13	55	75	273	255	234	195	176	143	117	
VM8060-14	66	90	294	274	252	210	189	154	126	
VM8060-15	66	90	315	294	270	225	203	165	135	
VM8060-16	75	100	336	314	288	240	216	176	144	
VM8060-17	75	100	357	333	306	255	230	187	153	
VM8060-18	93	125	378	353	324	270	243	198	162	
VM8060-19	93	125	399	372	342	285	257	209	171	
VM8060-20	93	125	420	392	360	300	270	220	180	

Nominal flow rate	1240 l/min
Flow range	150 - 1940 l/min
Head range	Up to 420 metres
Max. pump efficiency (η)	74%
Motor power	9,3 - 93 kW
Rated speed	2900 rpm
Pipe connection Raccordement de pipe	G 4

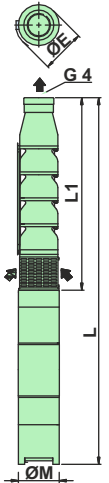

Pump type	P <sub>2</sub>		Dimensions						Gross weight [kg]			Gross volume [m <sup>3</sup> ]		
			L1 [mm]	ØE [mm]	WF motor				Pump	Pump + WFM		Pump	Pump + WFM	
					Size	ØM [mm]	L [mm]			1 ~	3 ~		1 ~	3 ~
							1 ~	3 ~						
VM8060-02	9,3	12,5	613	196	6"	142	-	1411	61,0	-	130,4	0,0880	-	0,1440
VM8060-03	15	20	743	196	6"	142	-	1676	79,0	-	163,4	0,0960	-	0,1620
VM8060-04	18,5	25	873	196	6"	142	-	1866	92,0	-	182,5	0,1030	-	0,1690
VM8060-05	22	30	1003	196	6"	142	-	2056	108,0	-	207,0	0,1260	-	0,1920
VM8060-06	30	40	1133	196	6"	142	-	2316	123,0	-	248,0	0,1380	-	0,2710
VM8060-07	37	50	1263	196	6"	142	-	2576	138,0	-	273,0	0,1510	-	0,2910
VM8060-08	37	50	1393	196	6"	142	-	2706	153,0	-	288,0	0,1640	-	0,3040
VM8060-09	45	60	1523	196	8"	190	-	2733	168,0	-	382,0	0,1760	-	0,3890
VM8060-10	45	60	1653	196	8"	190	-	2863	182,0	-	396,0	0,1900	-	0,4030
VM8060-11	55	75	1783	196	8"	190	-	3043	197,0	-	425,0	0,2030	-	0,4234
VM8060-12	55	75	1913	196	8"	190	-	3173	212,0	-	440,0	0,2160	-	0,4364
VM8060-13	55	75	2043	196	8"	190	-	3303	227,0	-	455,0	0,2280	-	0,4484
VM8060-14	66	90	2173	196	8"	190	-	3600	241,0	-	508,0	0,2410	-	0,4840
VM8060-15	66	90	2303	196	8"	190	-	3730	254,0	-	521,0	0,2470	-	0,4900
VM8060-16	75	100	2433	196	8"	190	-	3910	267,0	-	545,0	0,2540	-	0,5043
VM8060-17	75	100	2563	196	8"	190	-	4040	273,0	-	551,0	0,2610	-	0,5113
VM8060-18	93	125	2693	196	8"	190	-	4310	285,0	-	590,0	0,2680	-	0,5370
VM8060-19	93	125	2823	196	8"	190	-	4440	297,0	-	602,0	0,2750	-	0,5440
VM8060-20	93	125	2953	196	8"	190	-	4570	310,0	-	615,0	0,2820	-	0,5510

**Note:** ØE = For single cable motor maximum diameter of pump inclusive of cable guard.  
For two cable motor maximum diameter of pump inclusive of cable guard will increase by 4 mm.  
All dimensions in mm unless otherwise noted.



# VM8070

## Mixed Flow Pump Characteristic Curves & Technical Data

# 8"

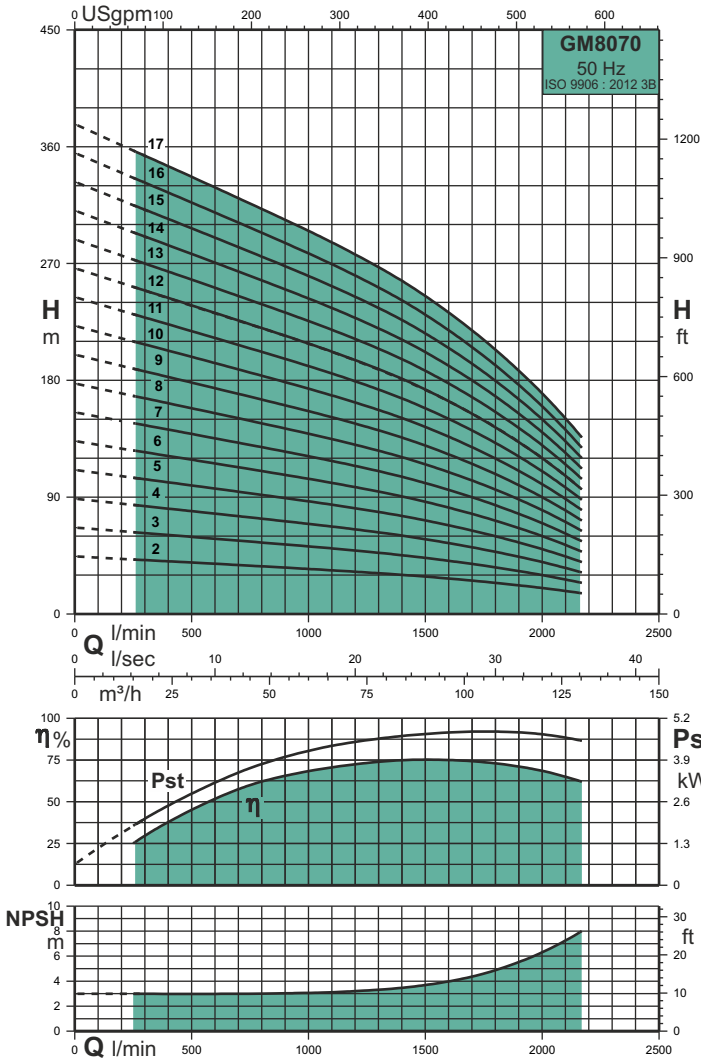

Pump type	P <sub>2</sub>		Q m <sup>3</sup> /h							
	kW	HP	0	43,2	64,2	85,2	103,2	120,0	130,2	
VM8070-02	11	15	44	37	34	30	25	20	16	
VM8070-03	15	20	67	56	51	45	38	30	24	
VM8070-04	22	30	89	74	68	60	50	40	32	
VM8070-05	26	35	111	93	85	75	63	50	40	
VM8070-06	37	50	133	112	102	90	76	60	48	
VM8070-07	37	50	155	130	119	105	88	70	56	
VM8070-08	45	60	178	149	136	120	101	80	64	
VM8070-09	55	75	200	167	153	135	113	90	72	
VM8070-10	55	75	222	186	170	150	126	100	80	
VM8070-11	55	75	244	205	187	165	139	110	88	
VM8070-12	66	90	266	223	204	180	151	120	96	
VM8070-13	66	90	289	242	221	195	164	130	104	
VM8070-14	75	100	311	260	238	210	176	140	112	
VM8070-15	93	125	333	279	255	225	189	150	120	
VM8070-16	93	125	355	298	272	240	202	160	128	
VM8070-17	93	125	377	316	289	255	214	170	136	

Nominal flow rate	1450 l/min
Flow range	250 - 2170 l/min
Head range	Up to 377 metres
Max. pump efficiency (η)	75%
Motor power	11 - 93 kW
Rated speed	2900 rpm
Pipe connection	G 5

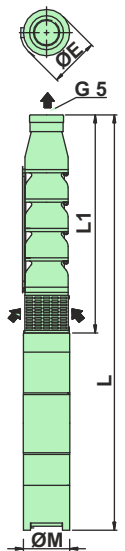

Pump type	P <sub>2</sub>		Dimensions						Gross weight [kg]			Gross volume [m <sup>3</sup> ]		
			L1 [mm]	ØE [mm]	WF motor				Pump	Pump + WFM		Pump	Pump + WFM	
					Size	ØM [mm]	L [mm]			1 ~	3 ~		1 ~	3 ~
							1 ~	3 ~						
VM8070-02	11	15	685	196	6"	142	-	1518	62,0	-	135,6	0,0880	-	0,1440
VM8070-03	15	20	820	196	6"	142	-	1753	78,0	-	162,4	0,1030	-	0,1690
VM8070-04	22	30	955	196	6"	142	-	2008	95,0	-	194,0	0,1130	-	0,1790
VM8070-05	26	35	1090	196	6"	142	-	2223	110,0	-	223,5	0,1260	-	0,2590
VM8070-06	37	50	1225	196	6"	142	-	2538	127,0	-	262,0	0,1380	-	0,2780
VM8070-07	37	50	1360	196	6"	142	-	2673	148,0	-	283,0	0,1640	-	0,3040
VM8070-08	45	60	1495	196	8"	190	-	2705	161,0	-	375,0	0,1640	-	0,3770
VM8070-09	55	75	1630	196	8"	190	-	2890	181,0	-	409,0	0,1900	-	0,4104
VM8070-10	55	75	1765	196	8"	190	-	3025	197,0	-	425,0	0,2030	-	0,4234
VM8070-11	55	75	1900	196	8"	190	-	3160	213,0	-	441,0	0,2120	-	0,4324
VM8070-12	66	90	2035	196	8"	190	-	3462	230,0	-	497,0	0,2280	-	0,4710
VM8070-13	66	90	2170	196	8"	190	-	3597	242,0	-	509,0	0,2400	-	0,4830
VM8070-14	75	100	2305	196	8"	190	-	3782	254,0	-	532,0	0,2520	-	0,5023
VM8070-15	93	125	2440	196	8"	190	-	4057	267,0	-	572,0	0,2660	-	0,5350
VM8070-16	93	125	2575	196	8"	190	-	4192	283,0	-	588,0	0,2790	-	0,5480
VM8070-17	93	125	2710	196	8"	190	-	4327	299,0	-	604,0	0,2920	-	0,5610

**Note:** ØE = For single cable motor maximum diameter of pump inclusive of cable guard.  
For two cable motor maximum diameter of pump inclusive of cable guard will increase by 4 mm.  
All dimensions in mm unless otherwise noted.



# VM8080

## Mixed Flow Pump Characteristic Curves & Technical Data

# 8"

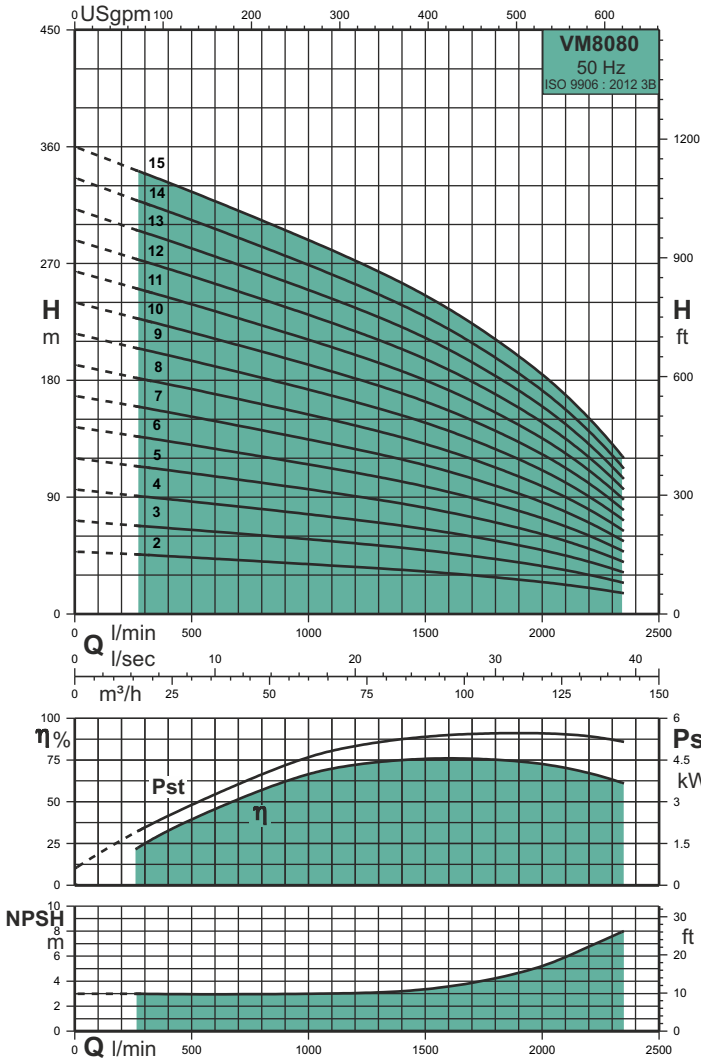

Pump type	P <sub>2</sub>		Q m <sup>3</sup> /h	0	62,4	84,0	96,6	121,8	132,3	141,0
	kW	HP								
VM8080-02	11	15	48	38	34	31	24	20	16	
VM8080-03	18,5	25	72	57	51	47	36	30	24	
VM8080-04	26	35	96	76	68	62	48	40	32	
VM8080-05	30	40	120	95	85	78	60	50	40	
VM8080-06	37	50	144	114	102	94	72	60	48	
VM8080-07	45	60	168	133	119	109	84	70	56	
VM8080-08	55	75	192	152	136	125	96	80	64	
VM8080-09	55	75	216	171	153	140	108	90	72	
VM8080-10	55	75	240	190	170	156	120	100	80	
VM8080-11	66	90	264	209	187	172	132	110	88	
VM8080-12	75	100	288	228	204	187	144	120	96	
VM8080-13	75	100	312	247	221	203	156	130	104	
VM8080-14	93	125	336	266	238	218	168	140	112	
VM8080-15	93	125	360	285	255	234	180	150	120	

Nominal flow rate	1610 l/min
Flow range	250 - 2350 l/min
Head range	Up to 360 metres
Max. pump efficiency (η)	76%
Motor power	11 - 93 kW
Rated speed	2900 rpm
Pipe connection	G 5

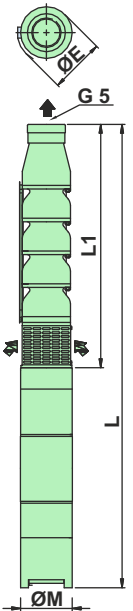

Pump type	P <sub>2</sub>		Dimensions						Gross weight [kg]			Gross volume [m <sup>3</sup> ]		
			L1 [mm]	ØE [mm]	WF motor				Pump	Pump + WFM		Pump	Pump + WFM	
					Size	ØM [mm]	L [mm]			1 ~	3 ~		1 ~	3 ~
							1 ~	3 ~						
VM8080-02	11	15	685	196	6"	142	-	1518	62,0	-	135,6	0,0880	-	0,1440
VM8080-03	18,5	25	820	196	6"	142	-	1813	78,0	-	168,5	0,1030	-	0,1690
VM8080-04	26	35	955	196	6"	142	-	2088	95,0	-	208,5	0,1130	-	0,2460
VM8080-05	30	40	1090	196	6"	142	-	2273	110,0	-	235,0	0,1260	-	0,2590
VM8080-06	37	50	1225	196	6"	142	-	2538	127,0	-	262,0	0,1380	-	0,2780
VM8080-07	45	60	1360	196	8"	190	-	2570	148,0	-	362,0	0,1640	-	0,3770
VM8080-08	55	75	1495	196	8"	190	-	2755	161,0	-	389,0	0,1640	-	0,3844
VM8080-09	55	75	1630	196	8"	190	-	2890	181,0	-	409,0	0,1900	-	0,4104
VM8080-10	55	75	1765	196	8"	190	-	3025	197,0	-	425,0	0,2030	-	0,4234
VM8080-11	66	90	1900	196	8"	190	-	3327	213,0	-	480,0	0,2120	-	0,4550
VM8080-12	75	100	2035	196	8"	190	-	3512	230,0	-	508,0	0,2280	-	0,4783
VM8080-13	75	100	2170	196	8"	190	-	3647	242,0	-	520,0	0,2400	-	0,4903
VM8080-14	93	125	2305	196	8"	190	-	3922	254,0	-	559,0	0,2520	-	0,5210
VM8080-15	93	125	2440	196	8"	190	-	4057	267,0	-	572,0	0,2660	-	0,5350

**Note:** ØE = For single cable motor maximum diameter of pump inclusive of cable guard.  
For two cable motor maximum diameter of pump inclusive of cable guard will increase by 4 mm.  
All dimensions in mm unless otherwise noted.



# VM8100

## Mixed Flow Pump Characteristic Curves & Technical Data

# 8"

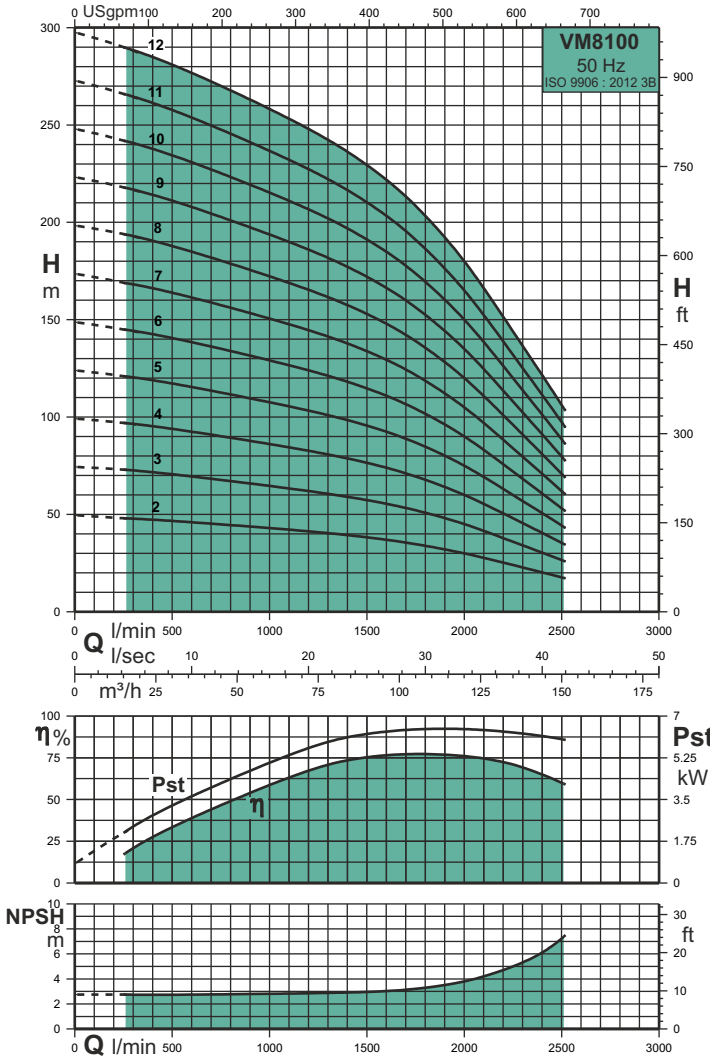

Pump type	P <sub>2</sub>		Q l/min	Q m <sup>3</sup> /h							
	kW	HP		0	80,4	100,2	120,0	135,0	144,6	151,2	
VM8100-02	15	20	H m	50	40	36	30	24	20	17	
VM8100-03	22	30		74	60	54	45	36	30	26	
VM8100-04	30	40		99	80	72	60	48	40	34	
VM8100-05	37	50		124	100	90	75	60	50	43	
VM8100-06	45	60		149	120	108	90	72	60	52	
VM8100-07	55	75		174	140	126	105	84	70	60	
VM8100-08	55	75		198	160	144	120	96	80	69	
VM8100-09	66	90		223	180	162	135	108	90	77	
VM8100-10	75	100		248	200	180	150	120	100	86	
VM8100-11	93	125		273	220	198	165	132	110	95	
VM8100-12	93	125		298	240	216	180	144	120	103	

Nominal flow rate	2000 l/min
Flow range	250 - 2520 l/min
Head range	Up to 298 metres
Max. pump efficiency (η)	77%
Motor power	15 - 93 kW
Rated speed	2900 rpm
Pipe connection	G 5

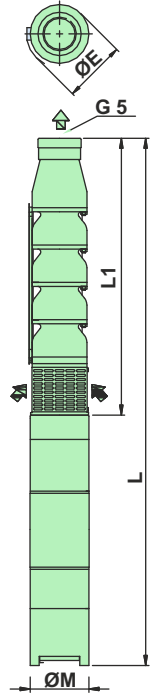

Pump type	P <sub>2</sub>		Dimensions						Gross weight [kg]			Gross volume [m <sup>3</sup> ]		
			L1 [mm]	ØE [mm]	WF motor				Pump	Pump + WFM		Pump	Pump + WFM	
					Size	ØM [mm]	L [mm]			1 ~	3 ~		1 ~	3 ~
							1 ~	3 ~						
VM8100-02	15	20	685	196	6"	142	-	1618	62,0	-	146,4	0,0880	-	0,1540
VM8100-03	22	30	820	196	6"	142	-	1873	78,0	-	177,0	0,1030	-	0,1690
VM8100-04	30	40	955	196	6"	142	-	2138	95,0	-	220,0	0,1130	-	0,2460
VM8100-05	37	50	1090	196	6"	142	-	2403	110,0	-	245,0	0,1260	-	0,2660
VM8100-06	45	60	1225	196	8"	190	-	2435	127,0	-	341,0	0,1380	-	0,3510
VM8100-07	55	75	1360	196	8"	190	-	2620	148,0	-	376,0	0,1640	-	0,3844
VM8100-08	55	75	1495	196	8"	190	-	2755	161,0	-	389,0	0,1640	-	0,3844
VM8100-09	66	90	1630	196	8"	190	-	3057	181,0	-	448,0	0,1900	-	0,4330
VM8100-10	75	100	1765	196	8"	190	-	3242	197,0	-	475,0	0,2030	-	0,4533
VM8100-11	93	125	1900	196	8"	190	-	3517	213,0	-	518,0	0,2120	-	0,4810
VM8100-12	93	125	2035	196	8"	190	-	3652	230,0	-	535,0	0,2280	-	0,4970

**Note:** ØE = For single cable motor maximum diameter of pump inclusive of cable guard.  
For two cable motor maximum diameter of pump inclusive of cable guard will increase by 4 mm.  
All dimensions in mm unless otherwise noted.

